

Speech Module

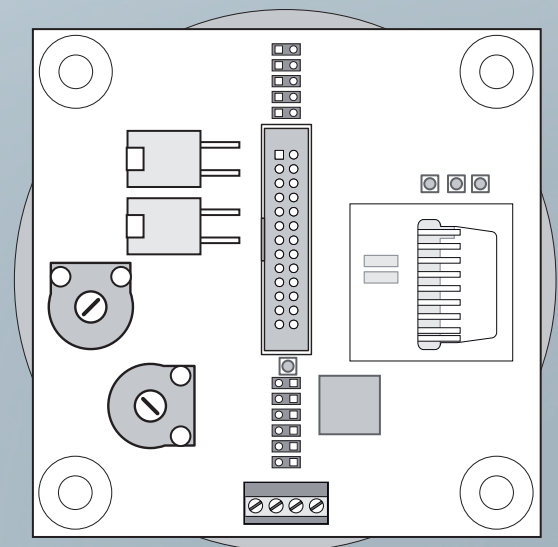
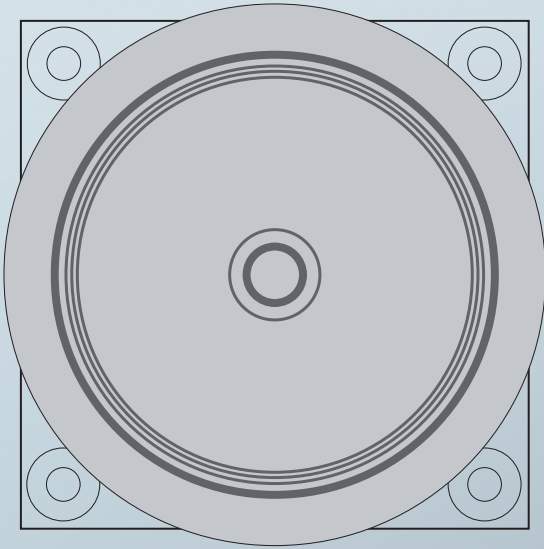

Manufacturer NEW *LIFT* Neue elektronische Wege
Steuerungsbau GmbH
Lochhamer Schlag 8
82166 Gräfelfing
Tel +49 89 - 898 66 - 0
Fax +49 89 - 898 66 - 300
Mail info@newlift.de
www.newlift.de

Service line Tel +49 89 - 898 66 - 110
Mail service@newlift.de

Date of issue 30.10.2013

Author TB

Last Change 26.01.2021 AME

Release 16.11.2020 AL

Hardware version SAM 5.70 2.1

Doc. No. hb_SAM_2020-09_en

Copyright © NEW *LIFT* Steuerungsbau GmbH, 2021.

This manual is protected by copyright. All rights, including those of copying, of reproduction, of translation and of modification, in whole or in part, are reserved by the publisher.

No part of this description may be reproduced in any form or copied with an electronic replication system without written permission.

Although great care has been taken in the production of texts and figures, we cannot be held legally liable for possible mistakes and their consequences.



Contents

1	General	4
1.1	Abbreviations, characters and symbols used	4
1.2	Notation	5
1.3	Further information	5
1.4	How to contact us	5
2	Safety	6
2.1	General safety regulations	6
2.1.1	Standards and regulations applied	6
2.1.2	Electromagnetic compatibility (EMC)	6
2.1.3	Handling electronic assemblies	6
3	SAM	7
3.1	Technical data	7
3.2	Pin assignment and configuration	7
3.2.1	Connections	7
3.2.2	Jumper	8
3.2.3	LED blink codes	8
4	SAM<i>Editor</i>	9
4.1	Legal information	9
4.2	Audio files	9
4.3	Configuration	10
4.4	Floor announcements	11
4.4.1	Floor announcements with additional information	12
4.4.2	An external file for a floor announcements	13
4.5	Event announcements	14
4.5.1	An external file for event announcements / messages	14
4.6	Background music	15
4.7	Saving of the completed project	16
4.8	Export projects	16
4.9	Import projects	18
4.10	Creating your own sound files with <i>SAMEditor</i>	19
4.11	Recording and post-processing of your own speech messages or music	20
4.11.1	Post-processing of existing audio files	21
4.12	Settings for <i>SAMEditor</i>	21
5	Configuration of the FST	22

1 General

The SAM speech module is a combination device with speech output facility for floor and event announcements such as door movements, travel direction, overload, special-drive etc. Independently of an in-house PA system the SAM can play background music. The compact design makes it very convenient for new installations, as well as for retrofitting into existing lifts since the wiring requirements are kept to a bare minimum. All necessary controls and connections, required during installation, are fitted on the rear side of the SAM speech module. Two potentiometers allow the maximum desired sound level for both channels (channel 1 is wired to the existing loudspeaker). FST menu allows to fine tune the volume of voice announcements and background music (preferably via hand terminal or remote control).

1.1 Abbreviations, characters and symbols used

Symbol / abbreviation	Meaning
SAM	Speech module
*	Delivery condition Settings that are supplied as standard are marked with an asterisk *
P	Power
I	Input
O	Output
L	low active
H	high active
▶	Operational instructions Perform the tasks that follow this symbol in the specified order.
	Warning notice This symbol is located in front of safety-relevant information
	Information notice This symbol is located in front of relevant information.

1.2 Notation

Notation	Meaning
Bold	› Designations of switches and actuators › Input values
<i>Italics</i>	› Captions › Cross references › Designations of functions and signals › Product names
<i>Bold italics</i>	› Remarks
LCD font	› System messages of the controller

1.3 Further information

The following documents, among others, are available for the FST control system and its components:

- › ADM Manual
- › EAZ 256 Manual
- › EAZ TFT.45.110.210 Manual
- › EN81-20 Manual
- › FPM Manual
- › FST-2XT/s Manual
- › FST-2XT MRL Manual
- › FST Installation & Commissioning Manual
- › GST-XT Manual
- › LCS Manual
- › RIO Manual
- › UCM-A3 Manual
- › Update-Backup-Analysis Manual

These and other up to date manuals can be found in the download area of our website at <https://www.newlift.de/downloads.html>

1.4 How to contact us

If, after referring to this manual, you still require assistance, our service line is there for you:

Phone +49 89 - 898 66 - 110
E-mail service@newlift.de
Mon. - Thurs.: 8:00 a.m. - 12:00 p.m. and 1:00 p.m. - 5:00 p.m.
Fr: 8:00 a.m. - 3:00 p.m.

2 Safety

2.1 General safety regulations

The SAM speech module must be in technically perfect condition and may only be used in accordance with regulations and in awareness of safety and risks. The “FST Installation & Commissioning” manual as well as the relevant guidelines for the prevention of accidents and the guidelines of local power utilities must be observed.



Basically, the safety regulations of the FST manual and the FST manual installation & commissioning apply.

2.1.1 Standards and regulations applied

The SAM speech module complies with:

- › safety regulations for the construction and installation of passenger and goods lifts (DIN EN 81 Parts 1 and 2)
- › regulations for the erection of power installations with rated voltages of up to 1kV (DIN VDE 0100)
- › measures to prevent accidental contacts in the machine room (VDE 0106)
- › data sheet on safety measures during installation, maintenance and servicing or repair of lift systems (ZH1/312).

2.1.2 Electromagnetic compatibility (EMC)

An accredited inspection body has verified that the FST controller and its components comply with the standards, limits and test intensities according to EN12015/1995 and EN12016/1995.

The FST controller and its components are:

- › resistant against electrostatic discharges (EN 61000-4-2/1995)
- › resistant against electrostatic fields (EN 61000-4-3/1997)
- › resistant against transient disturbances (EN 61000-4-4/1995)

The field strengths of the electromagnetic disturbances radiated by the FST controller and its components do not exceed the permitted limits (EN 55011/1997).

2.1.3 Handling electronic assemblies

- › Leave electronic assemblies in their original packaging until installation.
- › Touch a grounded piece of metal prior to opening the original packaging to prevent damage from static charges.
- › During work on electronic assemblies, periodically perform this discharge procedure.
- › All bus inputs or outputs not in use must be equipped with a terminal resistor (terminator).

3 SAM

3.1 Technical data

Description	Value
Supply voltage	24 V DC ±10%
Typical current consumption: soundless / max. volume	80 mA / 250 mA
Outputs	short circuit proof
Length x Hight x Depth	96 x 96 x 42 mm
Temperature range: Storage & Transportation / Operation	-20 – +70 °C / ±0 – +60 °C
Relative humidity: Storage & Transportation / Operation (non-condensing).	+5 – +95 % / +15 – +85 %

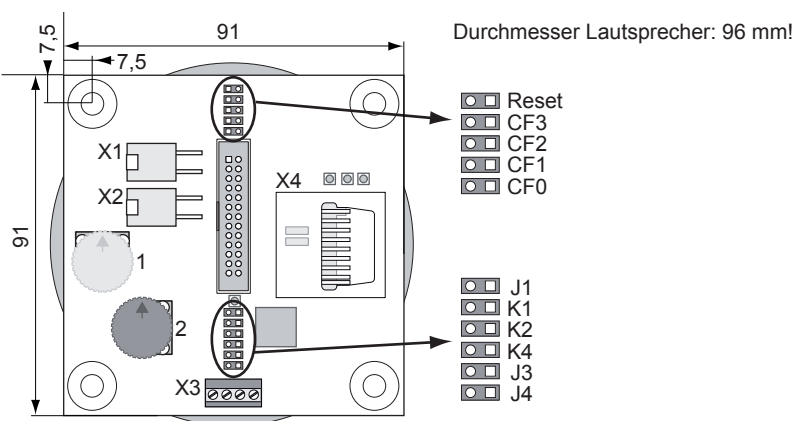

Circuit board drawing SAM

When fixing SAM, be sure to allow enough room around the SD-memory card slot to facilitate card removal and insertion.

3.2 Pin assignment and configuration

3.2.1 Connections

Bus connection X1 ... X2

Pin	Colour code	Signal / function
X1.1 = X2.1	black	RS-485 LON-Bus "A"
X1.2 = X2.2	white	RS-485 LON-Bus "B"
X1.3 = X2.3	red	Supply +24V
X1.4 = X2.4	magenta	Supply GND or 0V

Loudspeaker connection X3

X3.1	channel 1 loudspeaker + (8 Ohm)
X3.2	channel 1 loudspeaker - (8 Ohm)
X3.3	optional: channel 2 loudspeaker + (8 Ohm)
X3.4	optional: channel 2 loudspeaker - (8 Ohm)

SD-card slot X4

SD-memory card (capacity min. 256 MB, max. 2 GB) replacement must be carried out in de-energised state only!

3.2.2 Jumper

Jumper settings for FST group assignment

Settings	K1	K2	K4
FST A	open	open	open
FST B	inserted	open	open
FST C	open	inserted	open
FST D	inserted	inserted	open
FST E	open	open	inserted
FST F	inserted	open	inserted
FST G	open	inserted	inserted
FST H	inserted	inserted	inserted

Jumper settings for configuration

Jumper	Meaning
CF0	Update Mode, Firmware Update is loaded from SD-card
CF1	Diagnostics mode ON
CF2	Startup sound ON
CF3*	Software Version spoken once at startup

3.2.3 LED blink codes

Normal operation	<ul style="list-style-type: none"> › green LED ON › yellow LED blinks during speech output › red LED OFF
Start up	<ul style="list-style-type: none"> › red and yellow LED ON for approx. 1 s › all LEDs OFF for approx. 4 s › all LEDs ON for approx. 5 s › green LED only ON
Diagnostics mode	<ul style="list-style-type: none"> › green LED OFF › red und yellow LED blink
SD-card error	all LEDs blink (resets after approx. 2 min.)

4 **SAMEditor**

The following components are required for the commissioning and software configuration of the SAM:

- › speech Module SAM
- › FST-Software Version FST V1.100-0400 or later
- › SD-Memory Card with capacity minimum 256 MB, maximum 2 GB
- › SD-Card-Reader
- › PC-Program *SAMEditor* with the SAM sound library

4.1 **Legal information**

SAM sound library

The SAM sound library is and remains the property of NEW *LIFT* Steuerungsbau GmbH©. It is provided for the use with the *SAMEditor* and SAM speech module exclusively, and may not be used for any other purposes!

Copyright statements and licenses

Please remember to observe copyrighting rules for external audio files, i.e. those that you use for your SAM configuration. If you use copyrighting speech or music files for the sound files loaded into the SAM, you may be liable for license fees if these are played in public places. Please ensure that you use royalty free music if you want to avoid this liability. Any unauthorised use of the sound files loaded into the SAM violates against „GEMA“ regulations (German society for musical performing and mechanical reproduction rights), copyright statements and licenses or „Kunsturhebergesetz“ (German law regulating art and copyright questions). NEW *LIFT* Steuerungsbau GmbH will not have any responsibility for possible consequences!

4.2 **Audio files**

SAMEditor can use not only provided SAM sound library, but also external audio files for your SAM configuration.

The sound files should have the following characteristics:

- › Voice announcements: WAV-format, 22.050 KHz, mono, 16-Bit (will be automatically converted)
- › Background music:
 - » WAV-format: 22.050 KHz, mono, 16-Bit (will be automatically converted)
 - » MP3-format: 22.050 KHz, mono, 80 – 120 KBit/s variable bitrate

If MP3 music files have other characteristics, you need to copy the program LAME.EXE.

LAME.EXE is a free open-source MP3-Encoder which can be found and downloaded from the internet. *SAMEditor* is installed by default to the following folder C:/Programme/NewLift/SamEditor. Copy LAME.EXE into this folder.

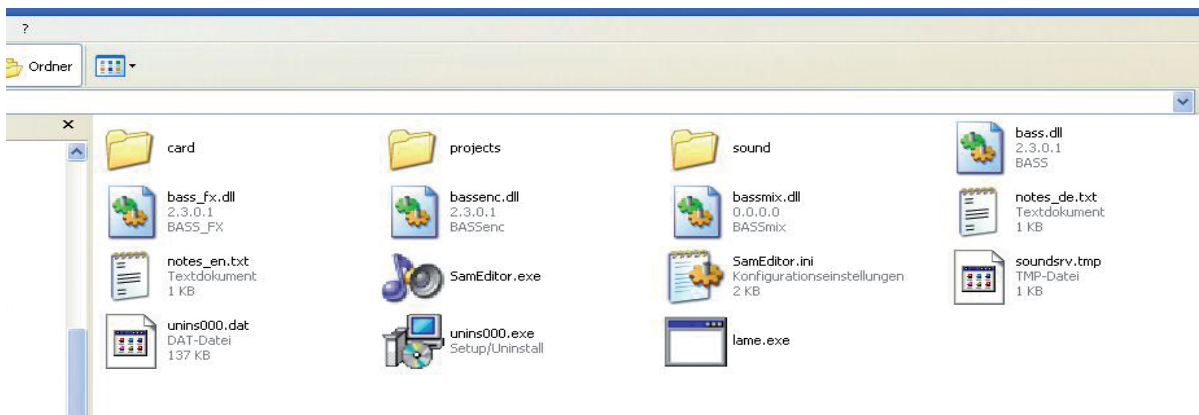

SamEditor folder view

4.3 Configuration

Please follow the steps in the order detailed below, in order to configure your SAM.

- › Install the SAMeEditor program on your PC or laptop
- › After starting SAMeEditor a new project must be created, to assign the information to individual floors, door-sides and other events. Open a new project by clicking on **New Project** on the menu bar.
- › A new window with the new project characteristics will open. Indicate the floor text abbreviations appropriate to each floor (0,1,...,40 / U1,U2,U3 / O1,O2,....,O9 / P1,P2,....,P9).

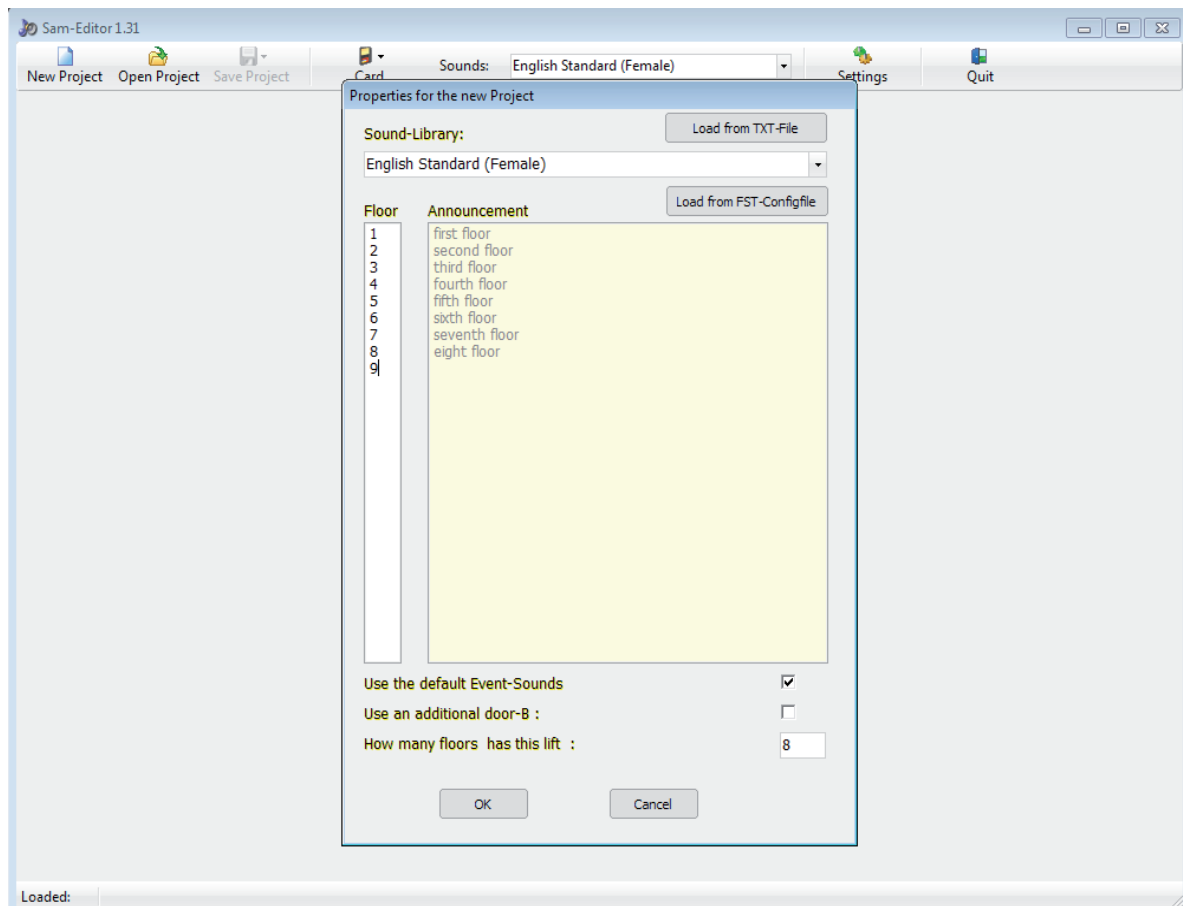

Enter project characteristics

4.4 Floor announcements

SAMeEditor will attempt to automatically select an arrival floor message to match the floor text abbreviation you have entered. If you want to suppress for a particular floor, simply enter „?“ character and select the sound file manually in one of the next steps.

For floors in which you don't want an arrival message, enter a „-“ character. If your lift has two door sides and you specifically want different arrival messages for each side, check the box **Use an additional door-B**. SAMeEditor will then automatically reserve and generate a message slot for door side B. Confirm your settings with **OK**.

By clicking the button **Load from FST-Configfile** it's possible to use the parameters of the accordingly FST for SAM configuration, so you can take over the available values. The FST config file you can create with the FST editor **FSTEdit**, with you can freely download from the NEWLIFT homepage.

After you have confirmed the project settings, the floor-messages and the standard events will be generated. You can test the results by clicking on the different messages in the project window. To do that, select the floors you want to play with the mouse and play the message by clicking the **Play**-button. For floors with no message shown, no message will be played (you have previously entered an „?“ or an „-“).

If your lift has two door sides and you selected the 2nd door B at the project-configuration, SAMeEditor generates a floor-message in every floor for door B as well as door A. The next sections show you how to match them.

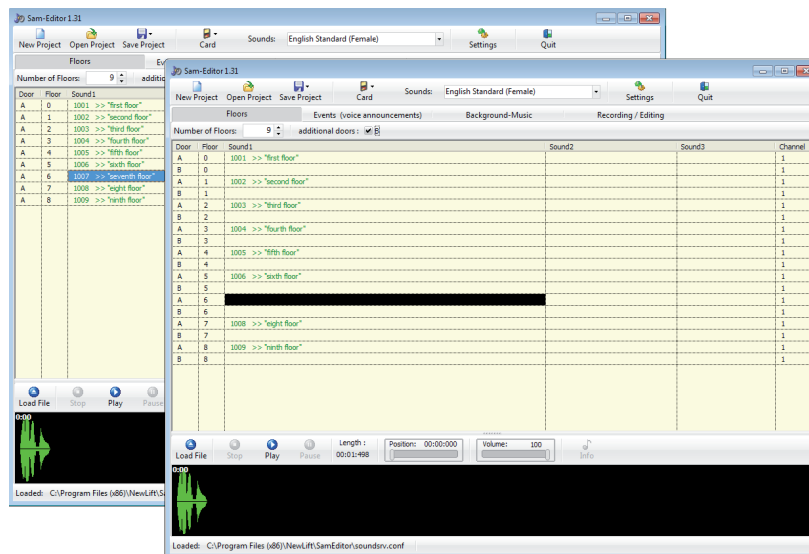

View of the floor-texts for a project with door side A and for a project with door sides A and B

If you are not satisfied with the generated floor announcements or if some floor announcements are still missing, you can change or create these in the next few steps. To change a floor name, double click on the floor you want to change. For floors which don't have an entry (floors without announcement), double click on the free area next to the floor. Now a wide range of messages will be displayed in the **Sound-Dialog**.

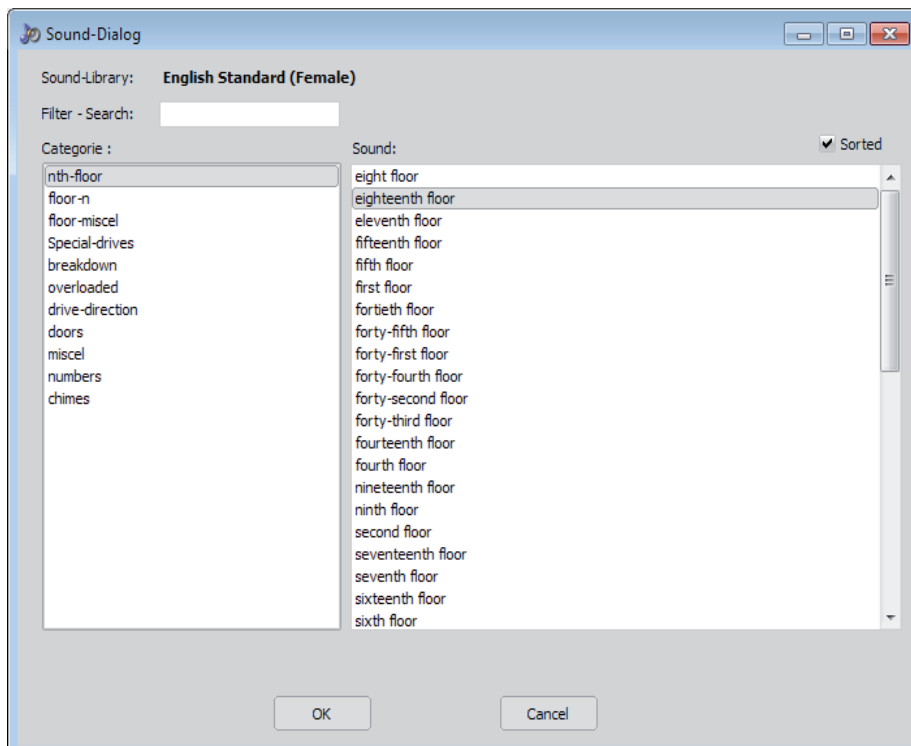

Diagram *Sound-Dialog*

The messages are organised in different categories. You can see the assigned message on the right by selecting a category. When you select a message, it will be displayed for control. When selecting, a message will be played, so you can hear how the message would sound later. Confirm your choice by clicking on OK. If you want to delete a floor message, select by clicking on it and then press **DEL** (resp. **ENTF**).

4.4.1 Floor announcements with additional information

There are more possibilities to change things. Until now the program assumes that only individual floor messages are required. Because of this, the SAMeEditor has only generated a single floor-message or a message for events. These messages are in column **Sound1**.

To generate multiple floor-messages, the other columns **Sound2** and **Sound3** can be used to add more messages. These can be used to describe more functions in the floor (for example exit, office, registration office etc.) and will be played after each other with a small break between each message.

Door	Floor	Sound1	Sound2	Sound3	Channel
A	0	1001 >> "first floor"			1
A	1	1002 >> "second floor"	3051 >> "bedrooms"	3002 >> "basement floor"	1
A	2	1003 >> "third floor"	3007 >> "car-park level-3"		1
A	3	1004 >> "fourth floor"	3042 >> "emergency service"		1
A	4	1005 >> "fifth floor"	3065 >> "Foyer"		1
A	5	1006 >> "sixth floor"	3068 >> "Platform"		1

Floor messages with additional information

In the figure above you can see composed floor messages. When arriving in floors 1 ... 4 the following outputs will be played:

Floor 1 = „gong – ground floor – exit“

Floor 2 = „1. upper floor – reception“

Floor 3 = „2. upper floor – cafeteria“

Floor 4 = „3. upper floor – the office for Civil Protection, fire and rescue services“

4.4.2 An external file for a floor announcements

If you want to use your own sound file for a floor message, select the according floor and confirm by clicking the **Load File button**.

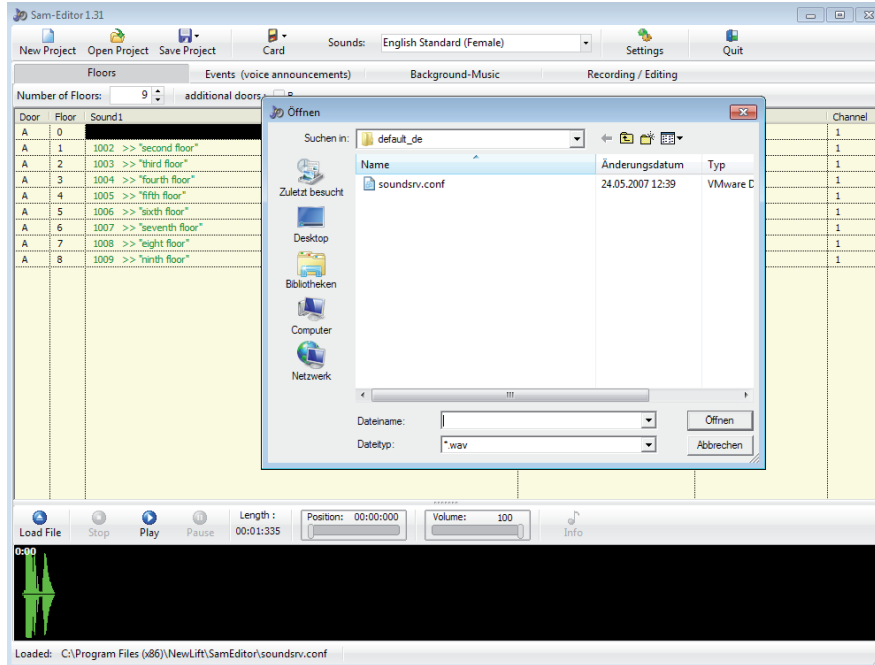

Choose your own sound file for a floor message

A separate file open dialog will open. Now you can choose your desired sound file. Please note, that you can use only WAV files. Ensure that you use royalty free music files to avoid liabilities. Of course, you can make your own voice-recording by SAMeEditor and use it for the floor-messages. In this case you can't breach copyrights or licenses. More detailed information on the subject of sound recording you can find in section 3.10 „Creating your own sound files with SAMeEditor“ on page 19.

4.5 Event announcements

You can assign messages to various lift events. The default configuration will have assigned most events with standard messages, which you can change. Same as in case of floor announcements you can play and change event announcements. You can find the events from the tab-menu **Events** (voice announcements).

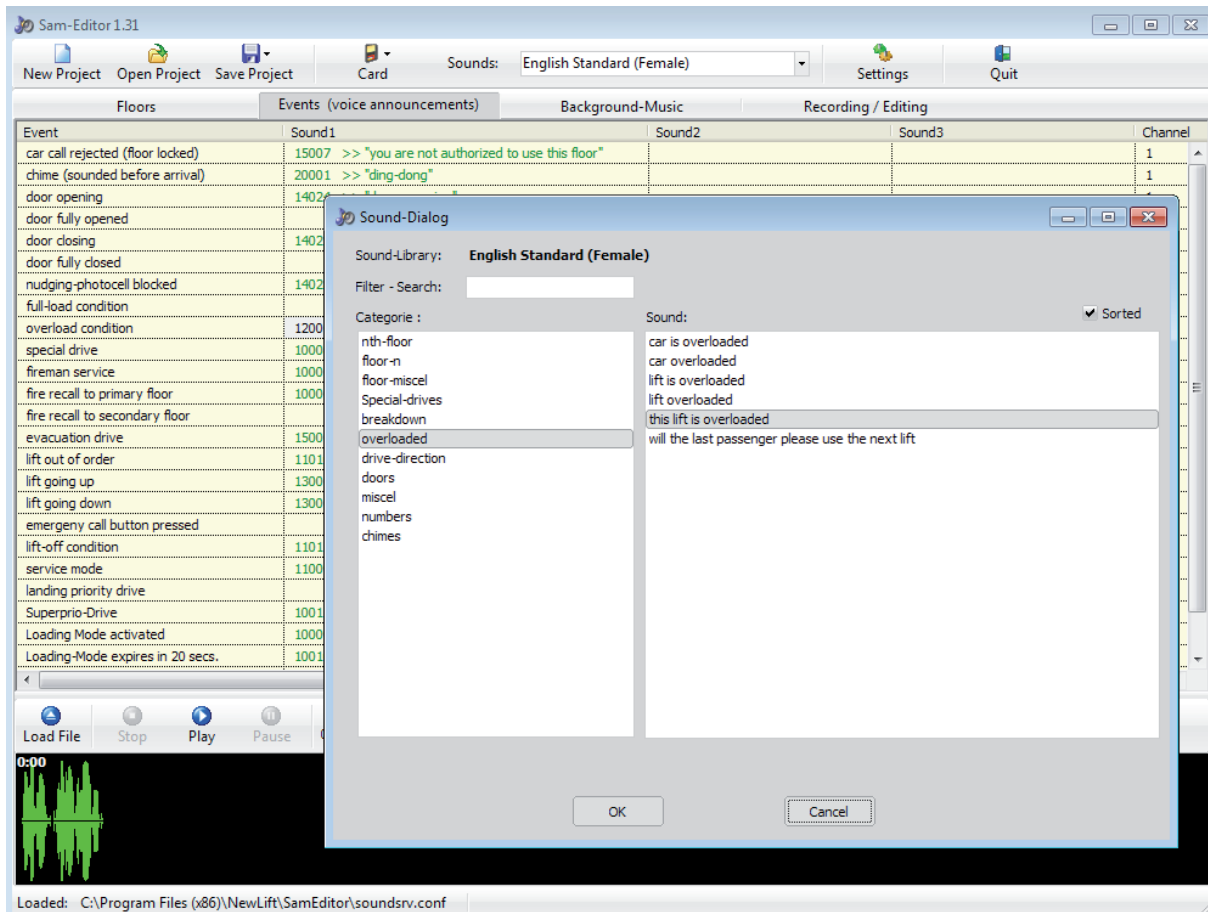

Changing the event speech message

You can click on selected messages and listen to them to control the sound. Confirm your choice by clicking on OK.

4.5.1 An external file for event announcements / messages

If you want to use your own event speech message, proceed in a similar method to the floor message selection by selecting the event and clicking on the button **Load File**. If you want to remove a message for an event, select it by clicking on it and press ENTF (resp. DEL).

Now you have completed the standard SAM-configuration.

4.6 Background music

To select background music files, start by clicking **Background-Music** in the tab-menu. Then click in the middle frame and select **Add a Background-Musicfile**. An open file dialog will appear, in which you can choose your desire sound file.

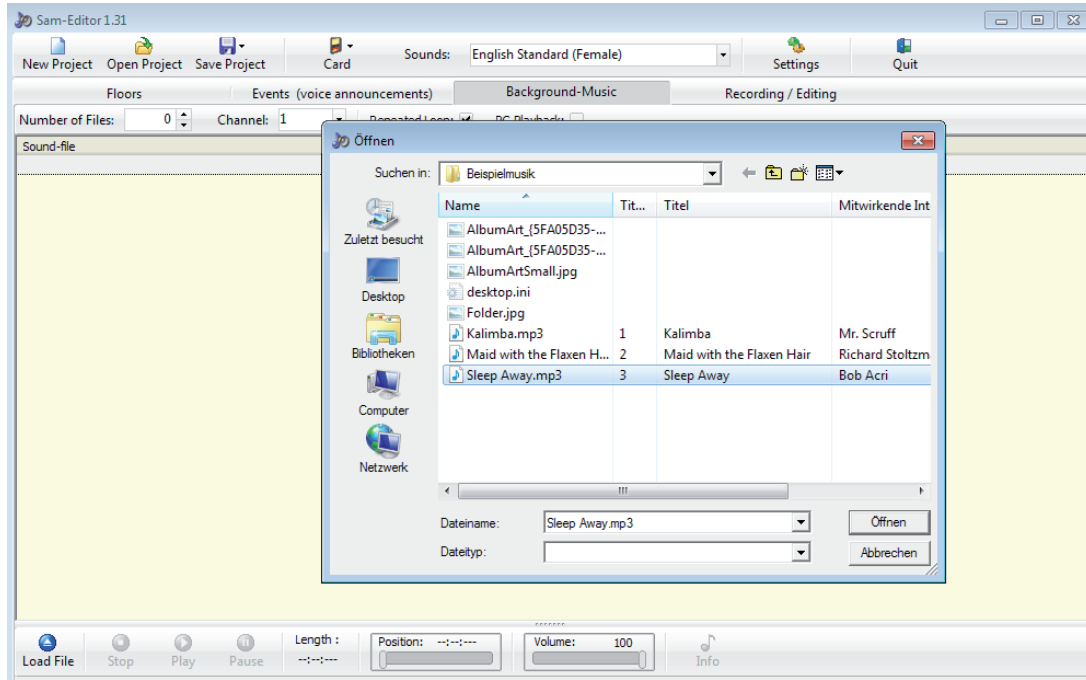

Selection of files for background music

In this way you can add as many music files to your project as the SD memory card hold (approx. 30 MB are reserved for the SAM system files now). Please note, that added music files are valid music files. Ensure that you use royalty free music files to avoid liabilities. You can use here WAV- and MP3 files. As well as in the above named sections you can listen here to corresponding files. Click on the music file you want to open and confirm by clicking on the button **Play** below.

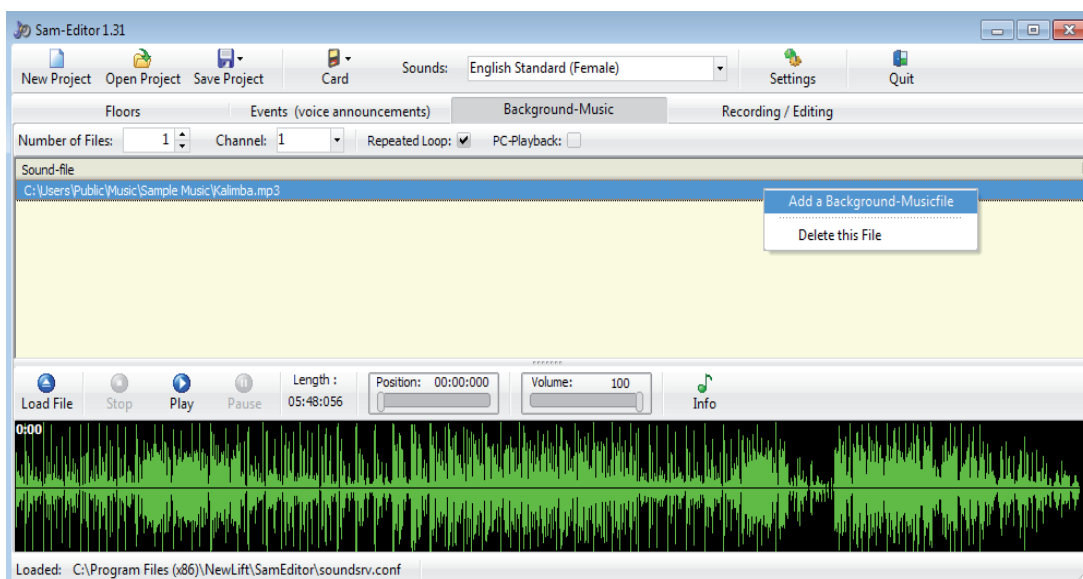

Play music files for background music

The SAM will play the music files in the same order as they are listed in the project window. To remove the background music file, click with the right mouse button on the selected file and then click on **Delete this File**

4.7 Saving of the completed project

The project is now correct configured and can be saved. You can re-open a saved project any time later and make changes in the same manner as you have done until now. To save click on **Save Project**. A save file dialog will appear in which you can see your project. Please create a new folder with the project name. In this project folder all configurations and all external audio files will be saved.

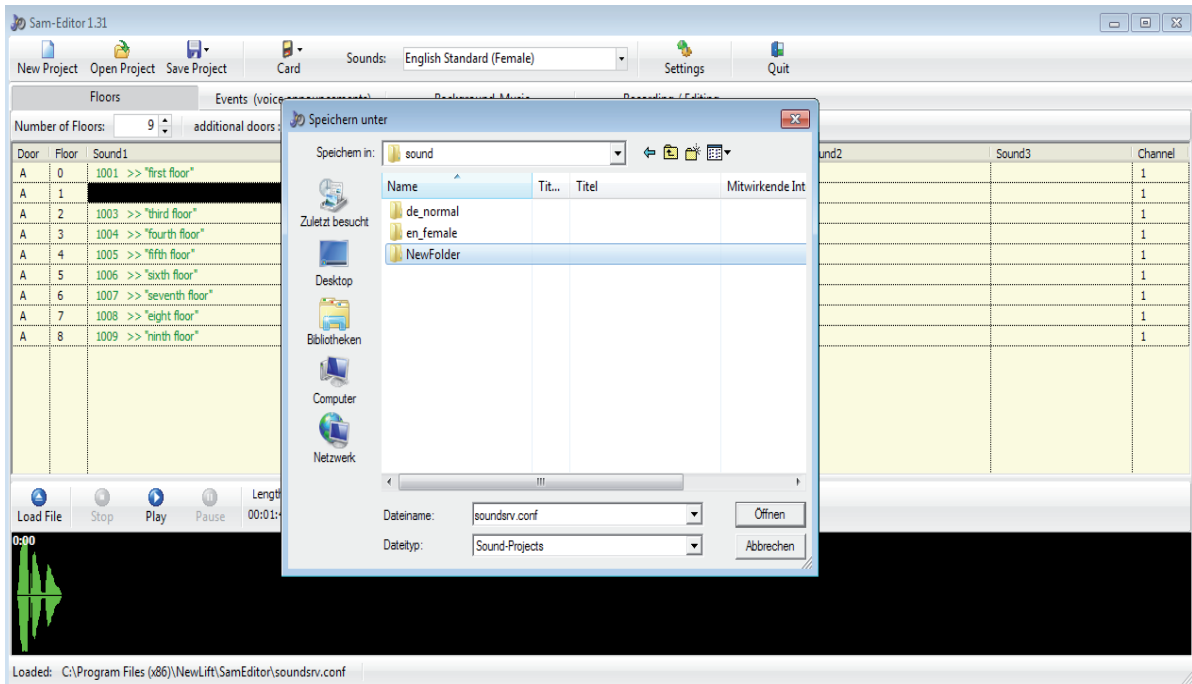

Saving the of the completed project



Notice: Before writing the SAM configuration to the SD-Card, the SAM-project must be saved!

4.8 Export projects

Now you can export the SAM sound system to your SD-Card. To do that, connect the card-reader to your computer (please refer to the manufacturers instructions). Then click on **Card** and select the Card-Drive. Select the according drive in this dialog and confirm by clicking on OK.

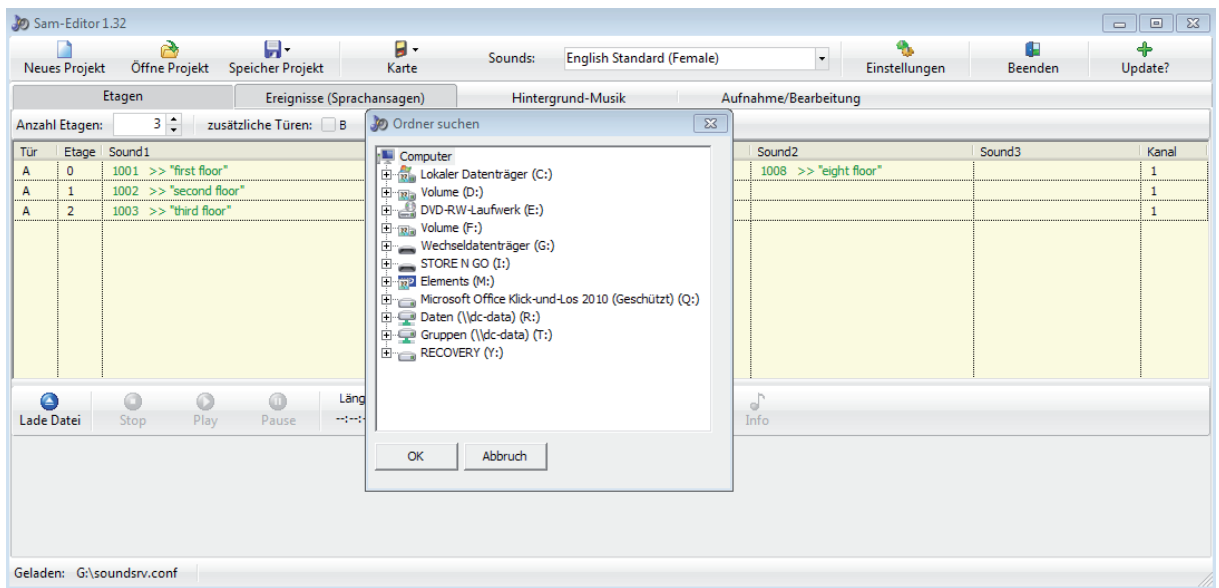

Choosing the Card-Drive

After selecting the card drive letter, this will be shown next to **Card**.

Now you can export the SAM sound system to your SD-Card. To do that, click on **Card** and then on **Export Project to Card**. In this window you can start the export by clicking on **Start Export**.

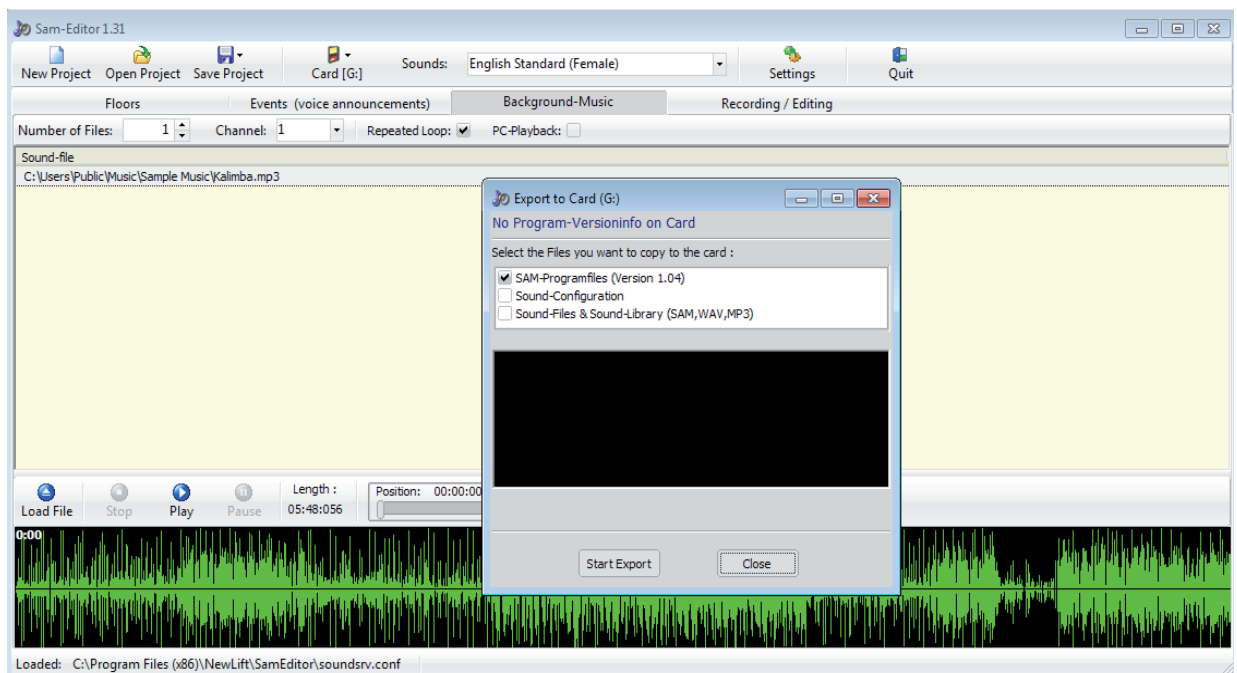

Export SAM configuration data to card

The SAM project is now complete. Simply insert the SD-Card into your SAM and switch on your lift.

4.9 Import projects

It can happen that you have an existing SAM configuration saved on a SD-Card without saved SAM configuration project on your PC. To save/archive this SAM configuration, you can import it from the SD-Card. To import the SAM configuration data, insert the SD-Card to your card reader. Click on **Card** and then on menu item **Import Project from Card**. In the import dialog enter the name of the project, under which name you want to save the SAM configuration. If no drive letter appears here, you have to select the card drive first. Now click on **Start Import**. **SAMEditor** creates a new folder with your project name and saves an existing SAM configuration on the SD-Card. Afterwards you can edit this SAM configuration in the same way, how you can do with self-created configurations.

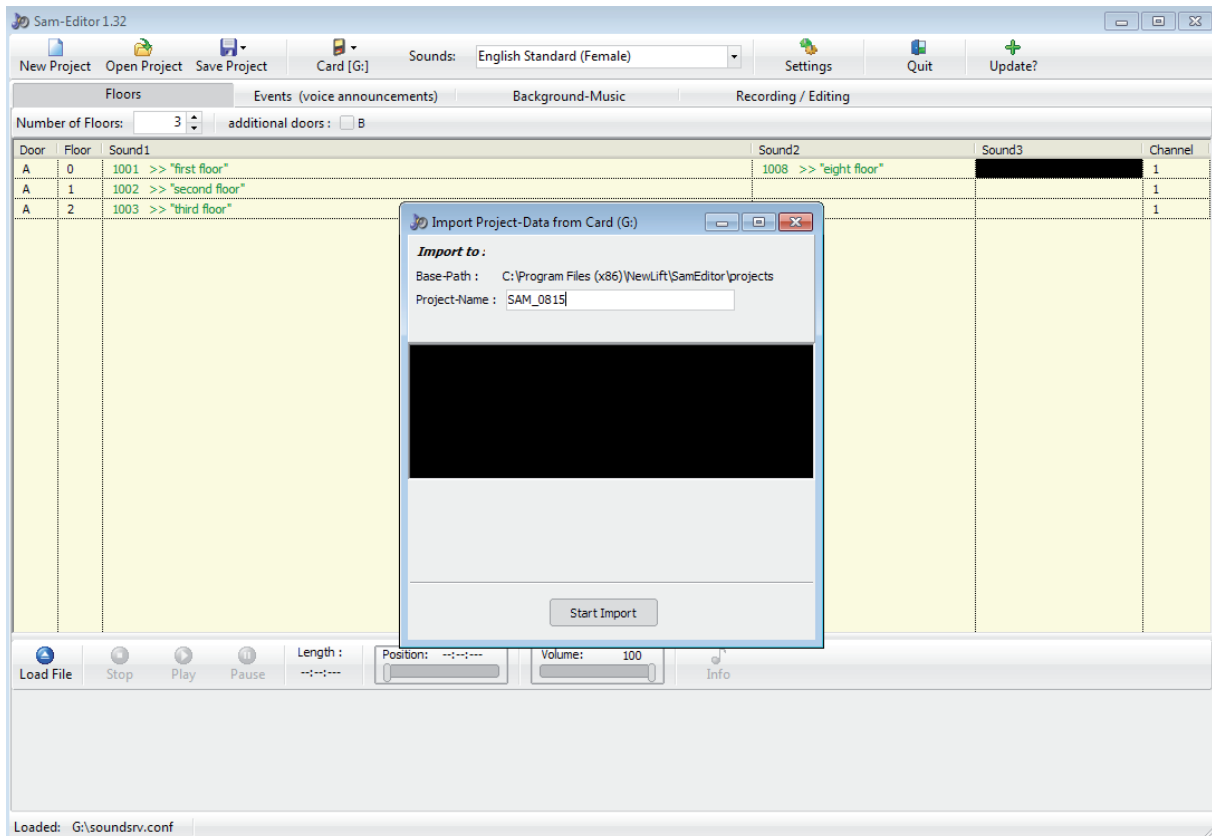

Import SAM configuration data from card

4.10 Creating your own sound files with SAMeEditor

Of course you can record your own floor and event speech messages. To record your own sounds, NEW Lift Steuerungsbau GmbH offers a SAM Recording Set, order-number 35-88510 which includes the following components:

- › Headset comprising stereo headphones and boom microphone
- › USB SD Memory Cards reader/writer
- › SD Memory Card
- › CD with PC-Software SAMeEditor, SAM sound library and this manual in PDF format.

The advantage of using this method is that you can always create valid sound files for direct use in SAMeEditor. Start by clicking on the tab-menu **Recording/Editing**.

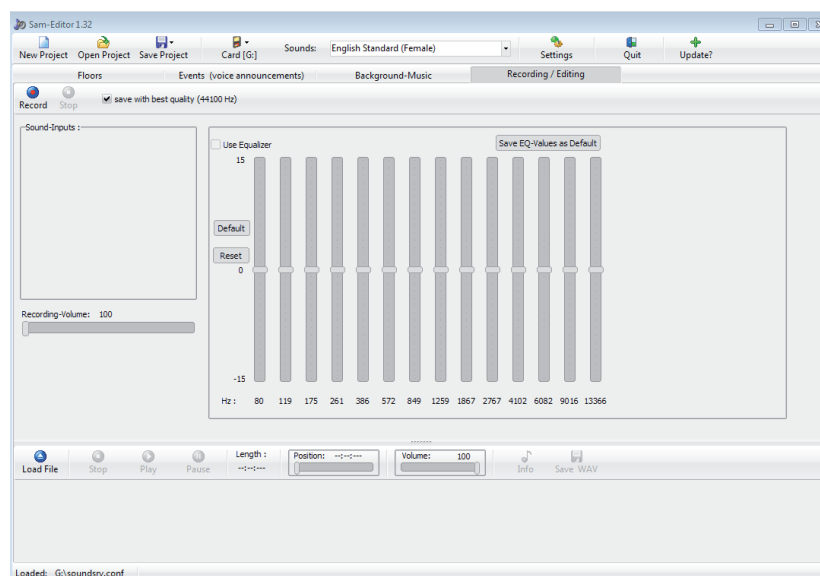

Recording and editing your own sound files

The recording and editing interface of SAMeEditor has following basic areas:

- › the sound source selection area for selecting the input signal source
- › the graphic equalizer for post-processing of the recorded sounds
- › the sound wave edit area for graphical visualization and to allow you to mark and select parts of your recording

Sound sources

The sound source list shows all the audio input devices available in your PC, which can be used to record an audio signal. This list on your PC can be completely different as shown in this example. Normally you would use a microphone as the sound source, if you want to record your own voice announcements.

Graphic equalizer

The graphic equalizer can help to correct the frequency response of the audio signals. The functionality of equalizer is assumed to be known and should not be described in detail here.

To use the equalizer to playback or to modify the sound before saving to disk, you have to enable it first.

Using the **Reset** button all the frequency sliders will be set to a neutral middle position „0“. If you want to save your current frequency response for re-use later, you can save the position of the sliders by clicking **Save EQ-Values as Default** and recall them by clicking to **Default**.

Sound wave edit area

In the sound wave edit area the actual audio signal is shown graphically as a sound wave. Using the mouse you can select an area (by clicking and dragging at the same time). The selected area can be played back with **Play** or saved with **Save WAV** or **Save MP3**. Selected areas of the audio signals will be shown highlighted. If nothing is marked, the whole audio signal is used for playing back or saving.

4.11 Recording and post-processing of your own speech messages or music

Recording your own speech messages or background music is done similar to other programs, which offer the same functionality.

First select the required sound source (mostly microphone).

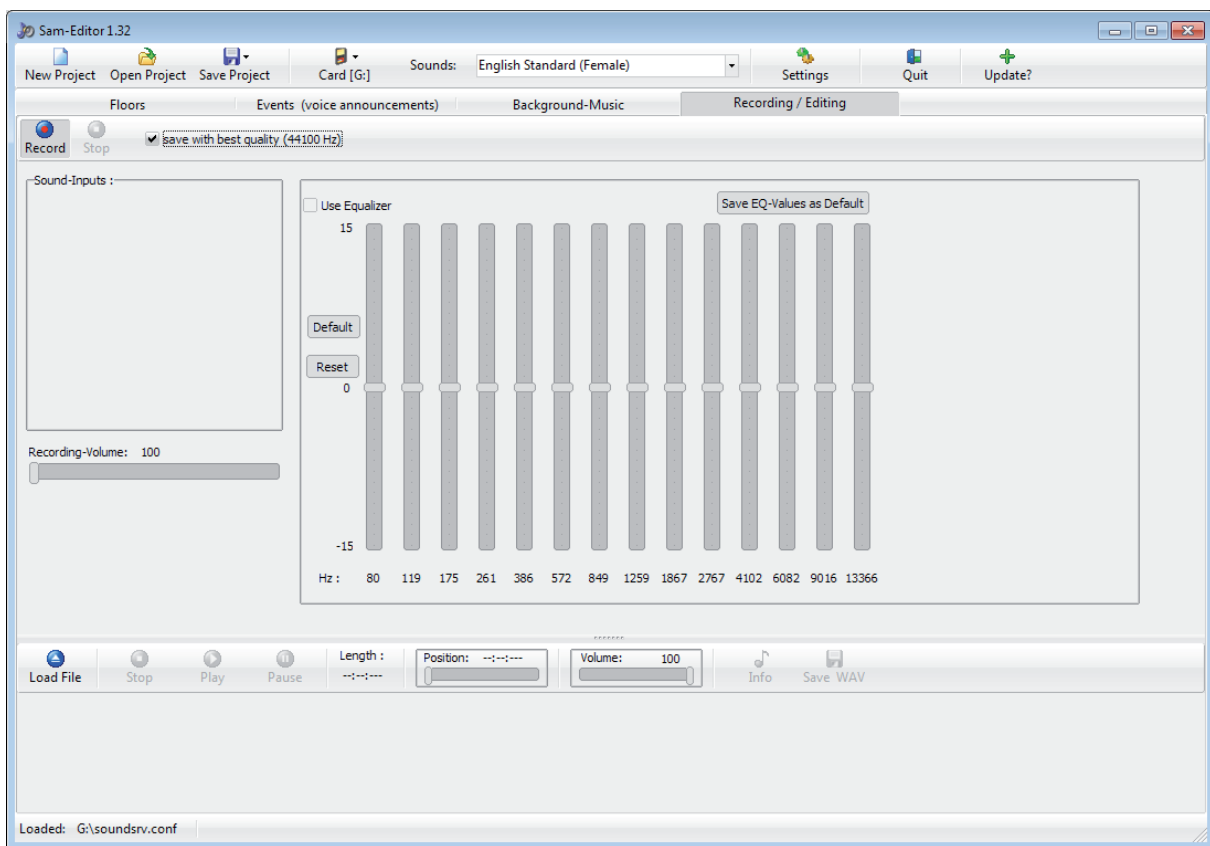

Recording of an audio signal

Recording is started by clicking on **Record**. During recording you can check the recording-volume in the small window and adjust the sensitivity if necessary.

With the **Stop** button the recording will be finished and the sound wave of the recorded audio signal will be shown in the bottom panel. Now you can playback the recording with **Play**, correct the frequency response by applying the equalizer and save the whole or a highlighted portion of the audio signal using **Save WAV** or **Save MP3**.



The button Save MP3 is only visible, when the program LAME.EXE is installed.

Use either of the buttons **Save WAV** or **Save MP3** to save the recorded and eventually postprocessed audio signal as an audio file the desired file format (speech messages must be saved as in WAV format). A save file dialog will appear allowing you to enter the file name of the audio file to be saved. If you have enabled the equalizer (box **Use Equalizer** is checked), a separate dialogue will ask you, if you want to apply the equalizer function to the audio signal saving or not.



We recommend you to save a newly recorded audio signal without the equalizer in order that you have an original raw sound file. Use this file afterwards to experiment with frequency correction using the equalizer. With each saving process the equalizer will be applied to the audio signal shown in the sound area, i.e. saving 5 times means applying the equalizer settings 5 times. This may cause unwanted distortion to your recording.

4.11.1 Post-processing of existing audio files

Of course, you can use SAMEditor for post-processing of existing audio files, e.g. to change the sound characteristic or save parts separately. To load an existing audio file, click on the button **Load File**.

An open file dialog will be appear, so you can choose the wanted audio file and confirm it with **Open**. The processing is similar to the processing of your recorded speech messages.

4.12 Settings for SAMEditor

With the dialog **Settings** menu you can set your preferences for working with SAMEditor.

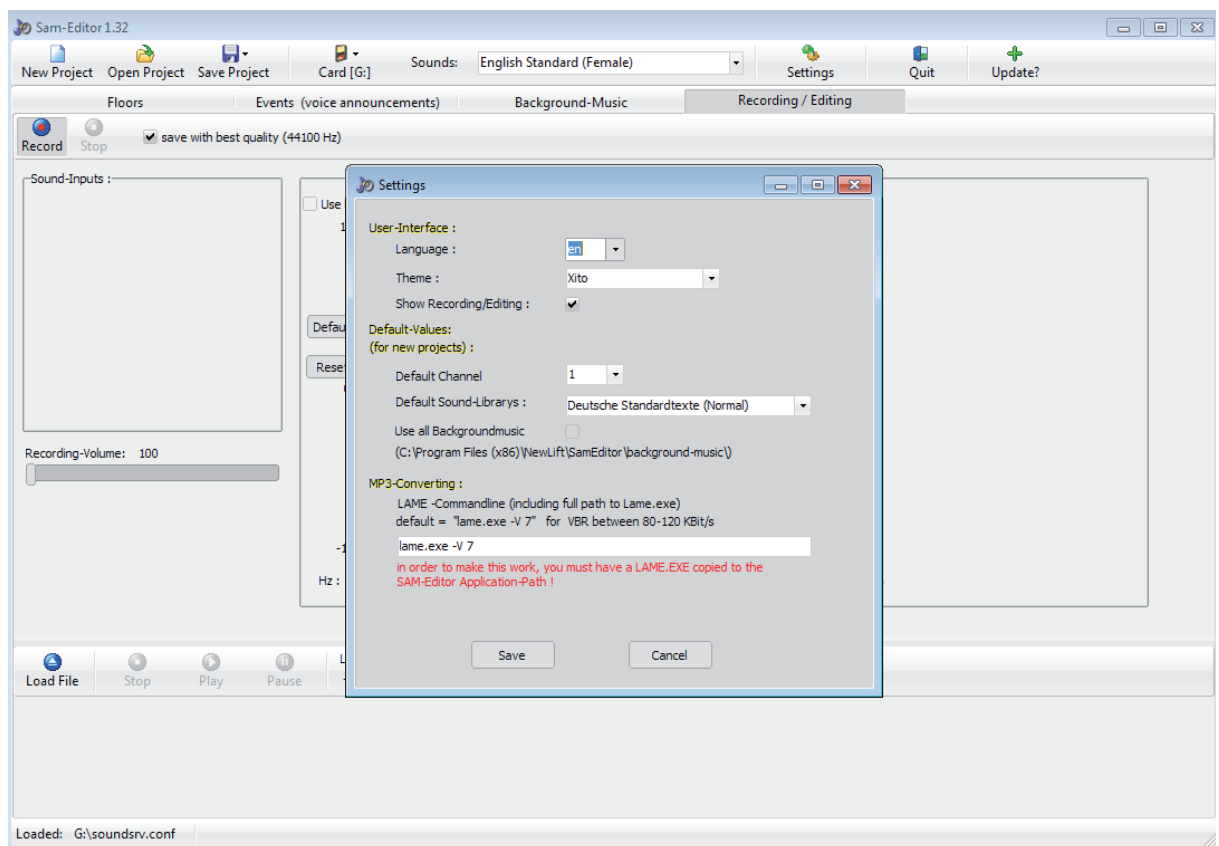

Settings for SAMEditor

We recommend adding royalty-free music files as background music to all SAM projects. Using the FST menu on-site the end-user can then decide if background music should be played or not.



*If you have checked box **Use all Backgroundmusic**, SAMEditor will add all audio files located in SAMEditor's system folder `C:/Programme/NewLift/SamEditor/background-music` as background music to your SAM project. If you note that audio files located there are royalty-free, you can ensure that you can always use background music in your lift system.*

5 Configuration of the FST

Further settings for the configuration of individual message types are offered in the FST menu under the menu item Config:

Menu item	Description	Setting range
Speech output Speech Module Type	Type selection of speech module. SPK-Module: the LON-Module SPK is the interface for the speech system. SAM-Module: Speech output (background music optionally) is possible via SAM.	SPK-Module SAM-Module
Speech output SAM-Module Volume 1	Speech output volume. This setting operates as a percentage of all speech output on both channels, i.e. 100 % is the currently set volume of both rear mounted volume control potentiometers 1 and 2.	0 ... 100 %
Speech output SAM-Module Volume 2	Background music output volume. This setting operates as a percentage on channel 1, i.e. 100 % is the set volume of rear mounted volume control potentiometer 1.	0 ... 100 %
Speech output SAM-Module Background music	Background music activated.	YES NO
Speech output SAM-Module Diagnostics mode	Enable the diagnostics mode. In this mode the message ID and corresponding speech phrases are announced.	YES NO
Speech output SAM-Module Message Repeat	Message repeat mode for fire/evacuation: 0 = message output once 1 = message repeated once after 10 s 2 = message repeated twice every 10 s 3 = message repeated continuously every 10 s	0 ... 3
Speech output SAM-Module „floor-X“ door A	Enable the floor announcement for door side A.	YES NO
Speech output SAM-Modul „floor-X“ door B	Enable the floor announcement for door side B.	YES NO
Speech output SAM-Module „door open/cls“	Enable the door opening/closing message.	YES NO
Speech output SAM-Module „door nudging“	Enable the door nudging message.	YES NO
Speech output SAM-Module „up/down“-early	Enable the intended departure direction message given out with the car door still open after the door „minimum wait-car“ time has expired.	YES NO
Speech output SAM-Module „up/down“-late		YES NO
Speech output SAM-Module „overloaded“	Enable the overloaded message.	YES NO
Speech output SAM-Module „out-of-order“	Enable the car out-of-order message.	YES NO

Menu item	Description	Setting range
Speech output SAM-Module „special-drive“	Enable the car-priority mode message.	YES NO
Speech output SAM-Module „evacuation“	Enable the evacuation mode message.	YES NO
Speech output SAM-Module „fire-recall“	Enable the fire-recall message.	YES NO
Speech output SAM-Module „fireman“	Enable the fireman service mode message.	YES NO
Speech output SAM-Module „lift-off“	Enable the Lift-off“ message.	YES NO
Speech output SAM-Module „service mode“	Enable the Service-Mode message.	YES NO
Speech output SAM-Module arrival gong	Enable the arrival gong.	YES NO
Speech output SAM-Module „emergency call“	Enable the emergency call activation message. When the emergency call button is pressed, the following message will be announced: „Your emergency call has been forwarded, please have some patience.“	YES NO

NOTES

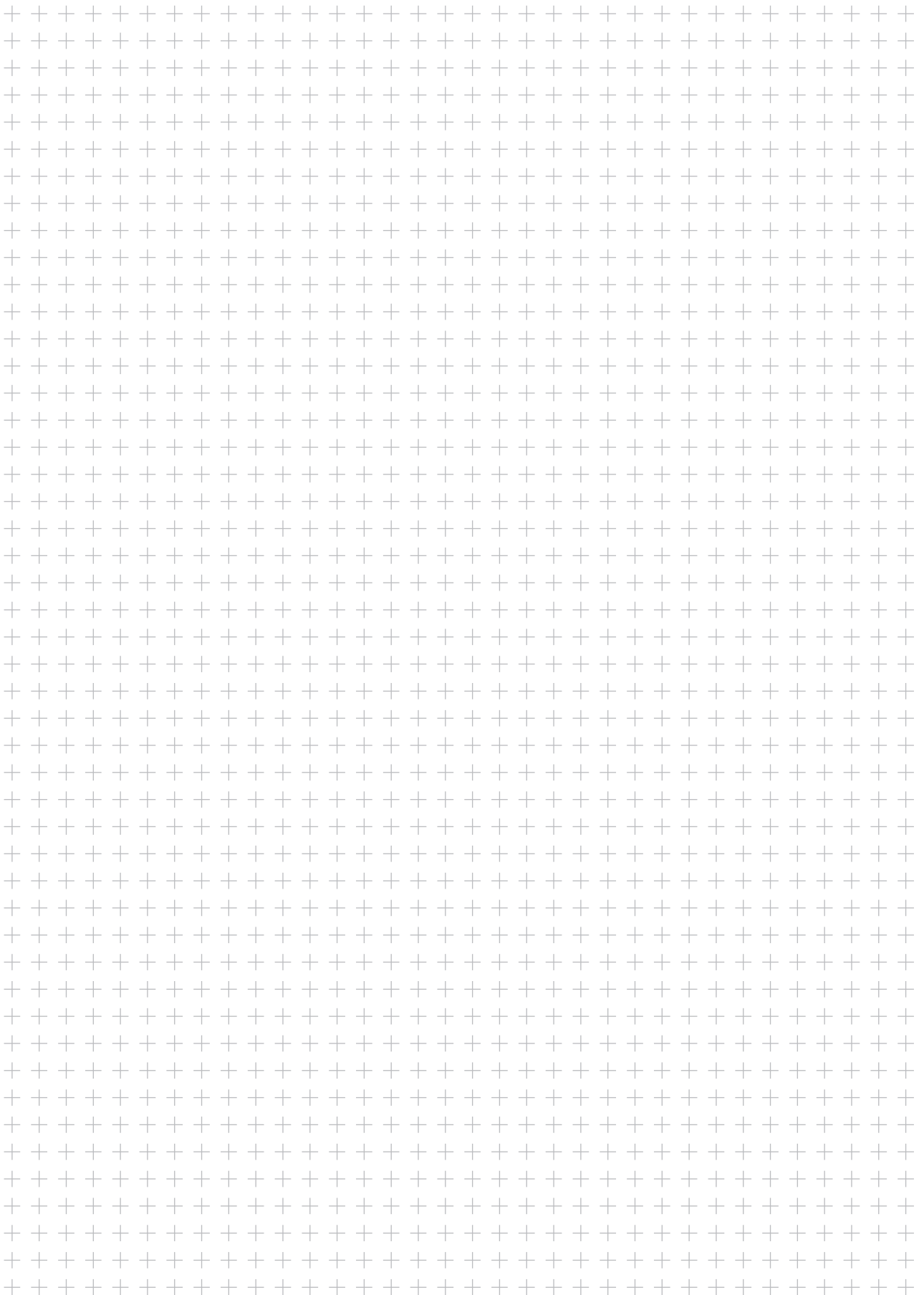

NOTES

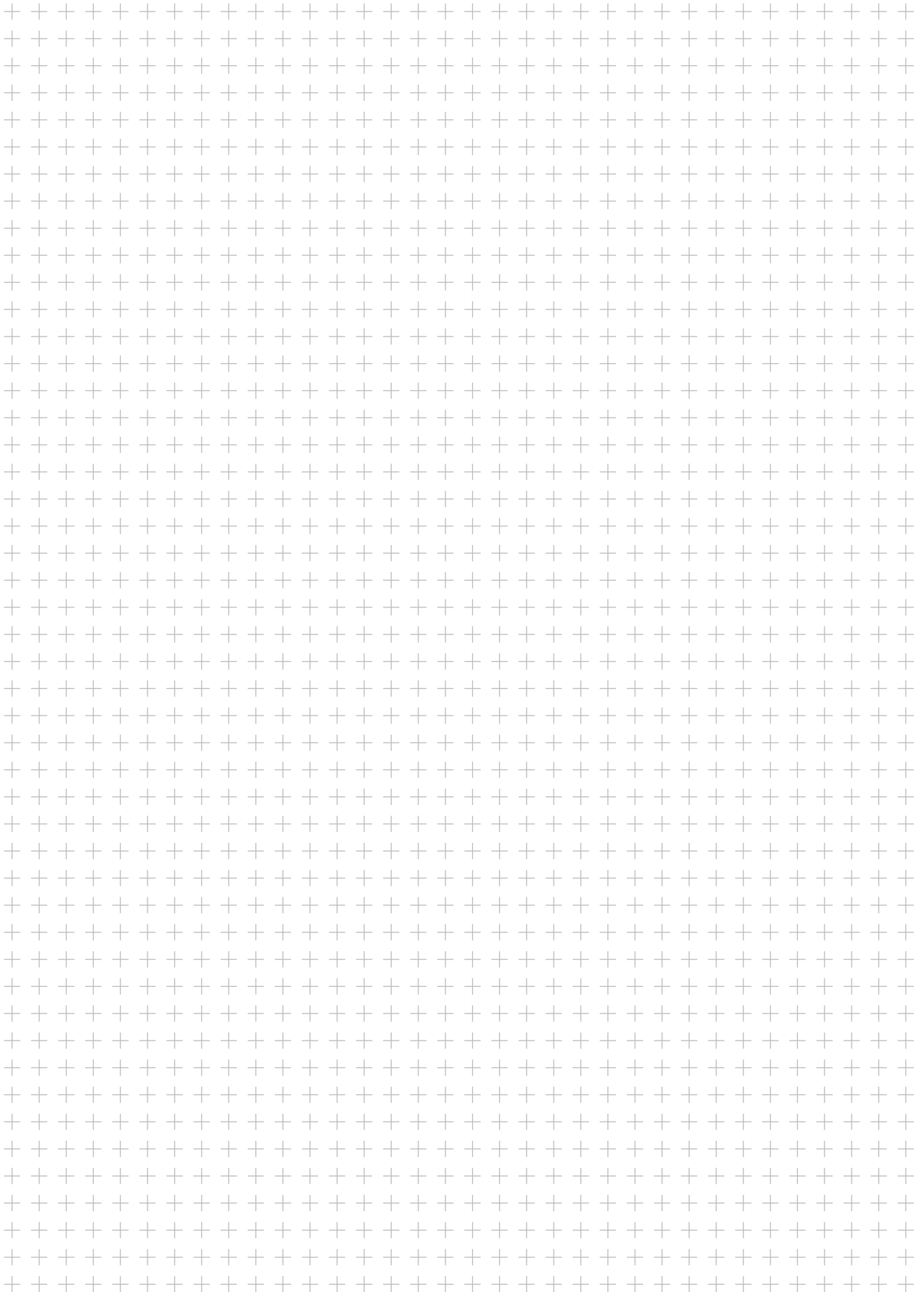

📍 **NEW LIFT** Neue Elektronische Wege

Steuerungsbau GmbH
Lochhamer Schlag 8
DE 82166 Gräfelfing

☎ +49 (0) 89 898 66 0
📠 +49 (0) 89 898 66 300
✉ info@newlift.de
🌐 www.newlift.de

📍 **NEW LIFT**

Service Center GmbH
Ruwerstraße 16
DE 54427 Kell am See

☎ +49 (0) 6589 919 540
📠 +49 (0) 6589 919 540 300
✉ info@newlift-sc.de
🌐 www.newlift.de